

X2M-02-414

DC COUPLED SMA DOUBLE BALANCED MIXER

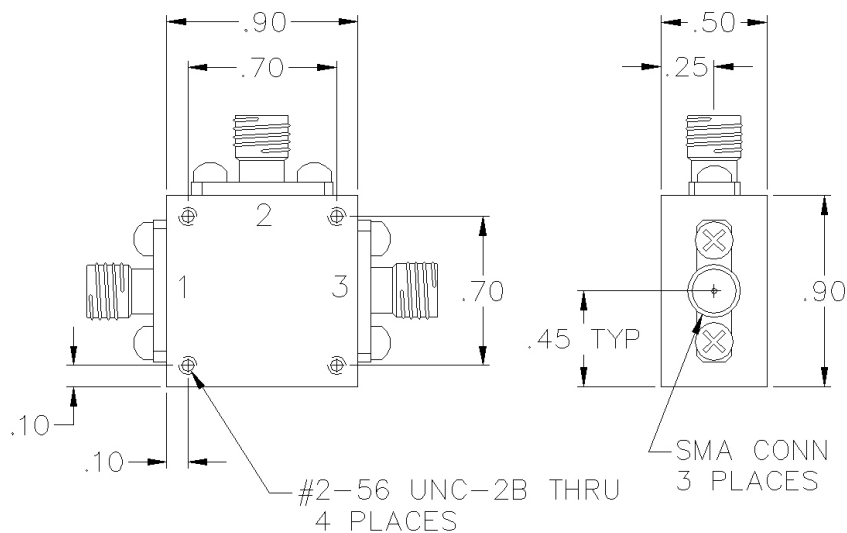

SPECIFICATIONS

Name:	X2M-02-414
Frequency Range:	
LO/RF:	0.01-125 MHz
IF:	DC-125 MHz
LO Drive:	+17 dBm
Conversion Loss:	6.0 dB max.
1 dB Compression Point:	+10 dBm typ.
Isolation:	
L/R:	40 dB min.
L/I:	35 dB min.
Connector Type:	SMA

PORT CONFIGURATION

RF:	1
LO:	3
IF:	2
Ground:	Housing

IF polarity is negative for DC coupled mixers.

This is a commercial off the shelf (COTS) product.

For an equivalent product that meets DFARS materials compliance, contact sales.

All specifications are subject to change without notice at any time. Rev: 220627

www.pulsarmicrowave.com · 48 Industrial St West, Clifton NJ 07012 · Tel: 973-779-6262 · Fax: 973-779-2727 · sales@pulsarmicrowave.com

PULSAR
MICROWAVE CORPORATION