

X2H-04-414

DC COUPLED DOUBLE BALANCED MIXER

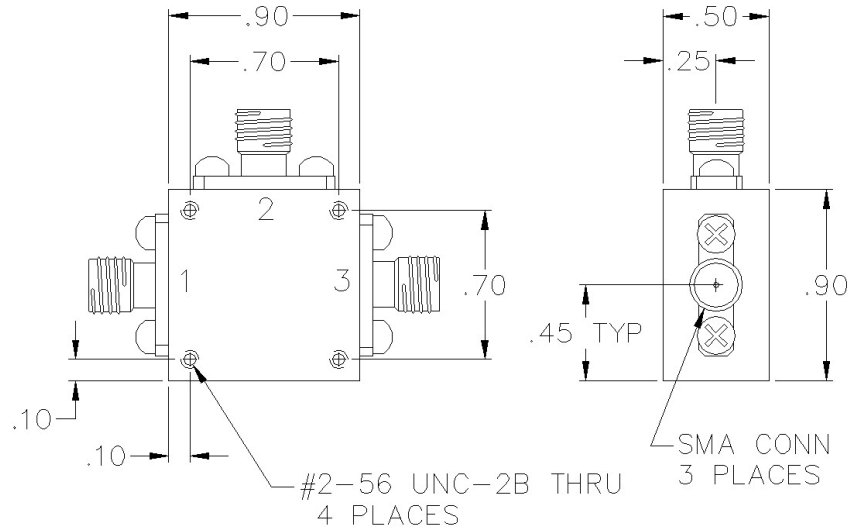

SPECIFICATIONS

Name:	X2H-04-414
Frequency Range:	
LO/RF:	0.1-750 MHz
IF:	DC-750 MHz
LO Drive:	+23 dBm
Conversion Loss:	8.0 dB max.
1 dB Compression Point:	+17 dBm typ.
Isolation:	
L/R:	25 dB min.
L/I:	20 dB min.
Connector Type:	SMA

PORT CONFIGURATION

RF:	1
LO:	3
IF:	2
Ground:	Housing

IF polarity is negative for DC coupled mixers.

This is a commercial off the shelf (COTS) product.

For an equivalent product that meets DFARS materials compliance, contact sales.

All specifications are subject to change without notice at any time. Rev: 250614