

X1L-11-414

AC COUPLED SMA TRIPLE BALANCED MIXER

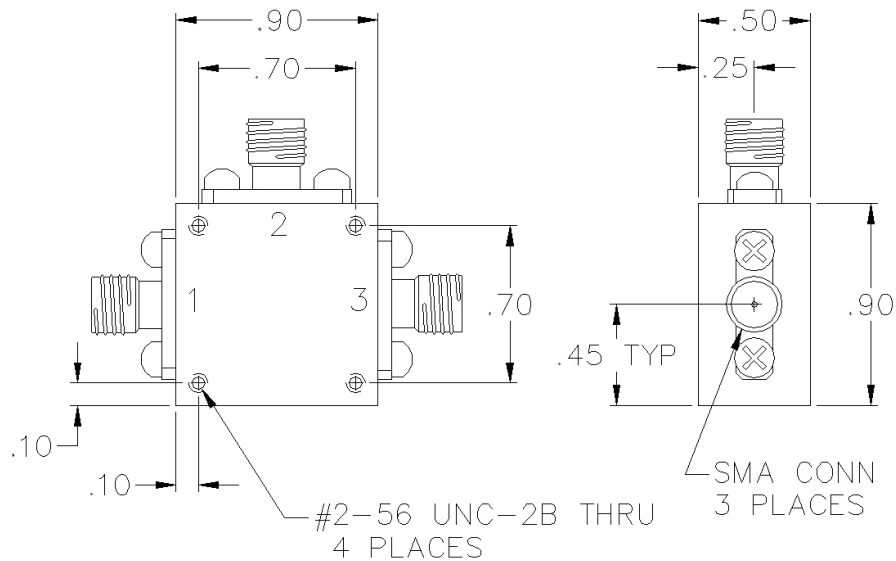

SPECIFICATIONS

Name:	X1L-11-414
Frequency Range:	
LO/RF:	5-4200 MHz
IF:	5-2000 MHz
LO Drive:	+10 dBm
Conversion Loss:	10.0 dB max.
1 dB Compression Point:	+5 dBm typ.
Isolation:	
L/R:	20 dB min.
L/I:	25 dB min.
Connector Type:	SMA

PORT CONFIGURATION

RF:	1
LO:	3
IF:	2
Ground:	Housing

This is a commercial off the shelf (COTS) product.

For an equivalent product that meets DFARS materials compliance, contact sales.

All specifications are subject to change without notice at any time. Rev: 220627