

ST-19-E

SURFACE MOUNT ANALOG PHASE SHIFTER

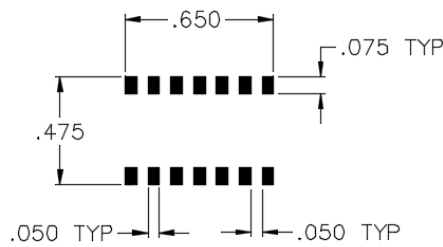

PCB PAD PATTERN
E-PHASE SHIFTER

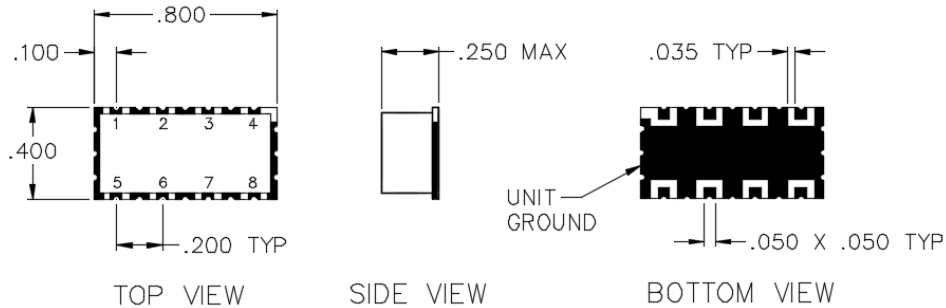
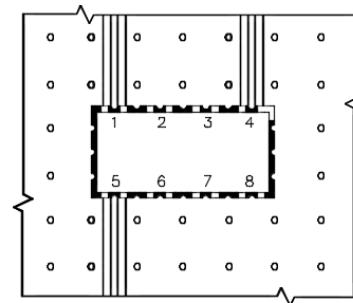

TYPICAL APPLICATION
ALL NON-USED PORTS AND UNIT GROUND
SHALL BE GROUND TO THE MAIN BOARD

SPECIFICATIONS

Name:	ST-19-E
Frequency Range:	1800-2000 MHz
Insertion Loss:	2.0 dB max.
Phase Shift:	180° min.
Control Voltage:	0-30 Volts
VSWR:	1.70:1 max.
Package Type:	Surface

PORT CONFIGURATION

Input:	5
Output:	1
Control:	4
Ground:	All Others

Maximum input power is +5 dBm.
Other frequencies, phase shift ranges, and control voltages available.

This is a commercial off the shelf (COTS) product.
For an equivalent product that meets DFARS materials compliance, contact sales.
All specifications are subject to change without notice at any time. Rev: 160203