

# ST-15-411

## ANALOG PHASE SHIFTER

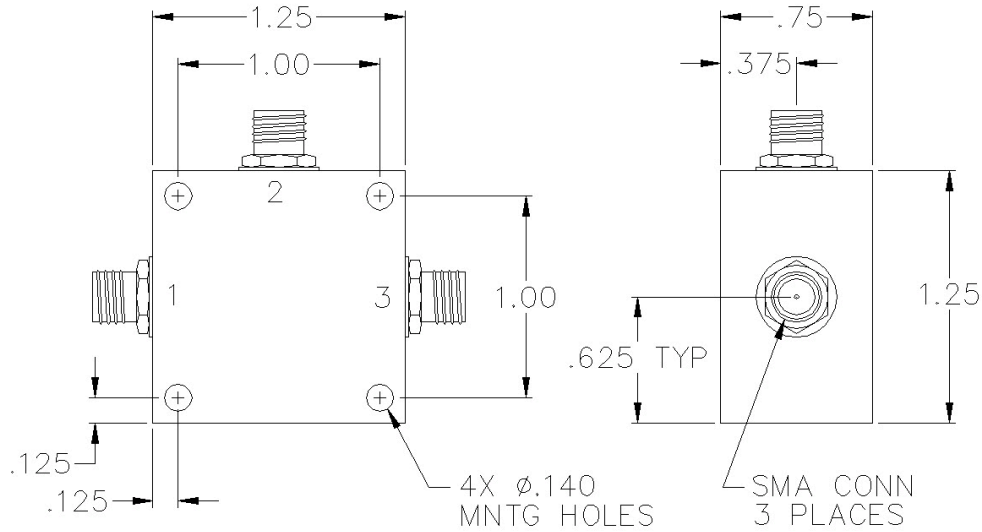

### SPECIFICATIONS

Name:	ST-15-411
Frequency Range:	1710-1735 MHz
Insertion Loss:	2.8 dB max.
Phase Shift:	180° min.
Control Voltage:	0-30 Volts
VSWR:	1.70:1 max.
Package Type:	SMA

### PORT CONFIGURATION

Input:	1
Output:	3
Control:	2
Ground:	Housing

Maximum input power is +5 dBm.  
Other frequencies, phase shift ranges, and control voltages available.

This is a commercial off the shelf (COTS) product.  
For an equivalent product that meets DFARS materials compliance, contact sales.  
All specifications are subject to change without notice at any time. Rev: 250614