

# ST-09-E

## SURFACE MOUNT ANALOG PHASE SHIFTER

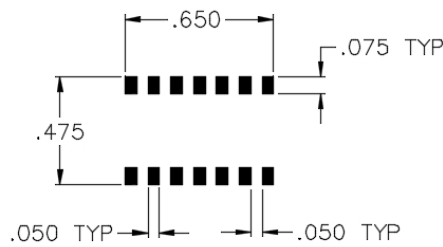

PCB PAD PATTERN  
E-PHASE SHIFTER

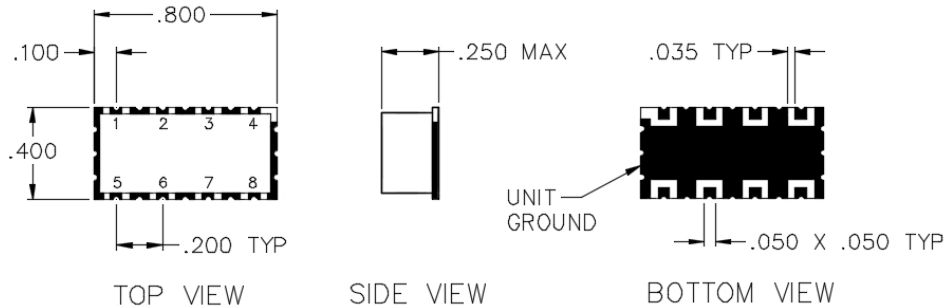
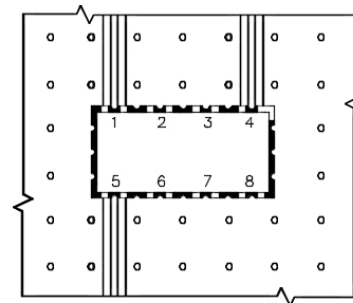

TYPICAL APPLICATION  
ALL NON-USED PORTS AND UNIT GROUND  
SHALL BE GROUND TO THE MAIN BOARD

## SPECIFICATIONS

Name:	ST-09-E
Frequency Range:	285-315 MHz
Insertion Loss:	1.7 dB max.
Phase Shift:	180° min.
Control Voltage:	0-30 Volts
VSWR:	1.70:1 max.
Package Type:	Surface

Maximum input power is +5 dBm.  
Other frequencies, phase shift ranges, and control voltages available.

## PORT CONFIGURATION

Input:	5
Output:	1
Control:	4
Ground:	All Others

This is a commercial off the shelf (COTS) product.  
For an equivalent product that meets DFARS materials compliance, contact sales.  
All specifications are subject to change without notice at any time. Rev: 160203