

ST-07-411

SMA ANALOG PHASE SHIFTER

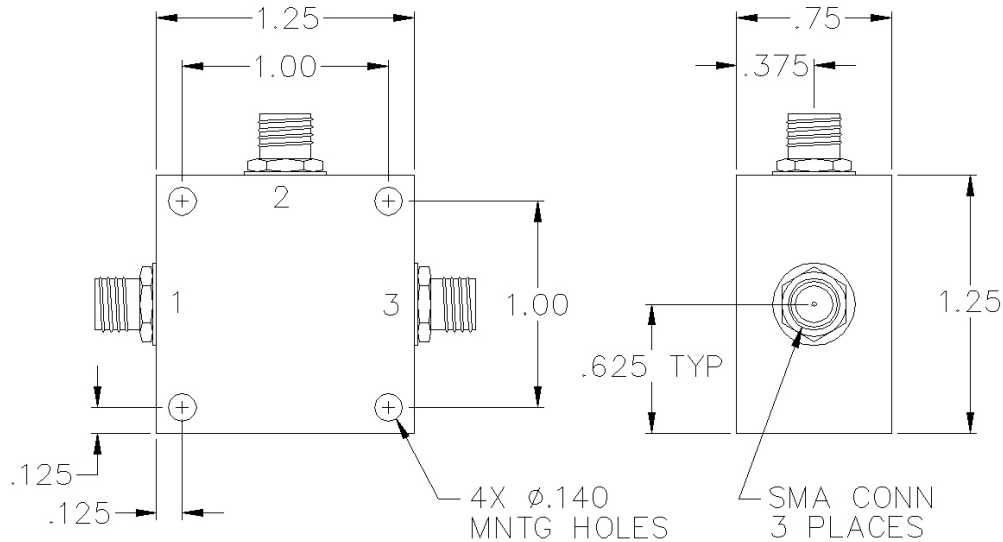
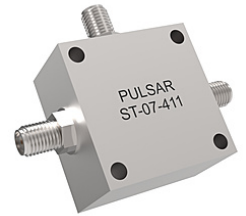

SPECIFICATIONS

| | |
|------------------|-------------|
| Name: | ST-07-411 |
| Frequency Range: | 133-147 MHz |
| Insertion Loss: | 1.5 dB max. |
| Phase Shift: | 180° min. |
| Control Voltage: | 0-30 Volts |
| VSWR: | 1.70:1 max. |
| Package Type: | SMA |

PORT CONFIGURATION

| | |
|----------|---------|
| Input: | 1 |
| Output: | 3 |
| Control: | 2 |
| Ground: | Housing |

Maximum input power is +5 dBm.
Other frequencies, phase shift ranges, and control voltages available.