

QT-14-412

3 DB SMA 90° HYBRID COUPLER

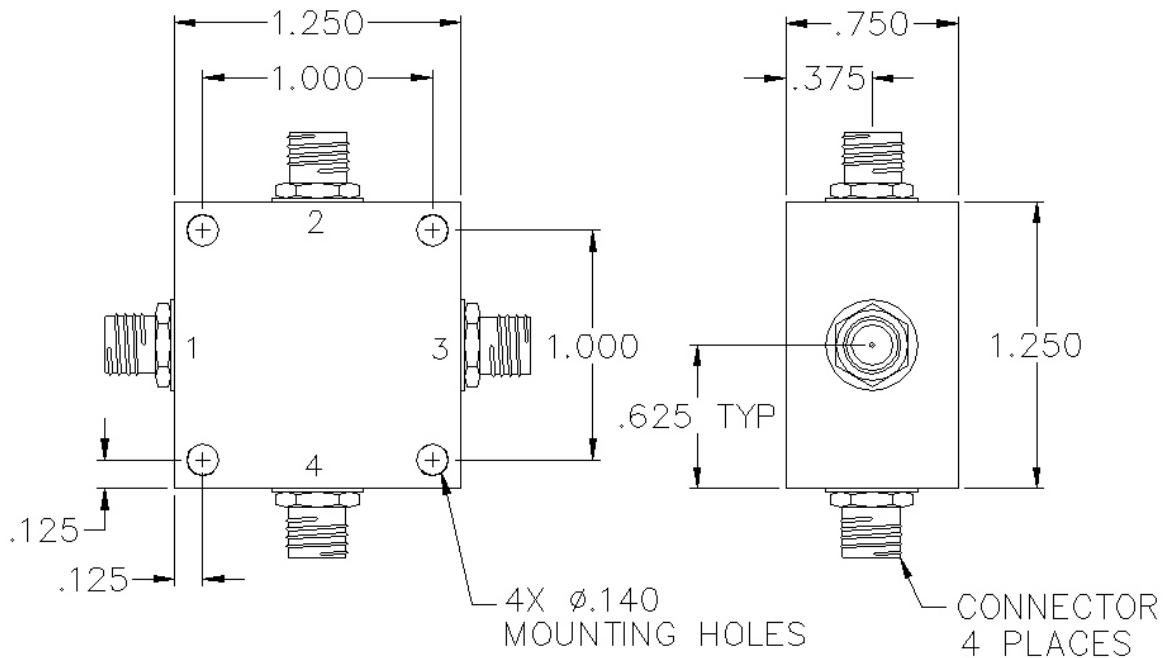

SPECIFICATIONS

Name:	QT-14-412
Bandwidth:	10%
Center Frequency:	40 MHz
Frequency Range:	38-42 MHz
Insertion Loss:	0.3 dB max.
Isolation:	25 dB min.
Amplitude Balance:	0.7 dB max.
Phase Balance:	2° max.
VSWR:	1.20:1 max.
Package Type:	SMA

PORT CONFIGURATION

Input:	1
90° Output:	4
0° Output:	2
Isolated:	3
Ground:	Housing

Power rating 1 watt max. for load VSWR better than 1.20:1.

Dimensions are in inches. Decimal tolerance: 2 Place: $\pm .02$, 3 Place: $\pm .010$
All specifications are subject to change without notice at any time. Rev: 190326

www.pulsarmicrowave.com · 48 Industrial St West, Clifton NJ 07012 · Tel: 973-779-6262 · Fax: 973-779-2727 · sales@pulsarmicrowave.com

PULSAR
MICROWAVE CORPORATION