

QT-11-D

3 DB SURFACE MOUNT 90° HYBRID COUPLER

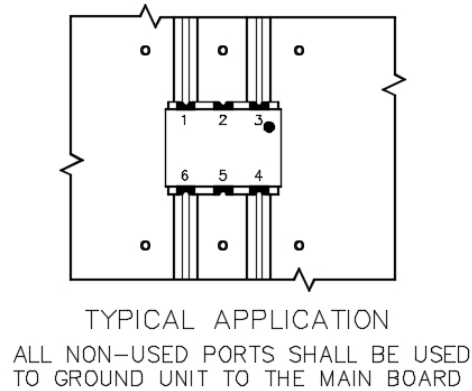
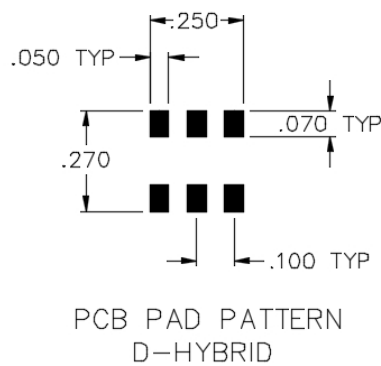
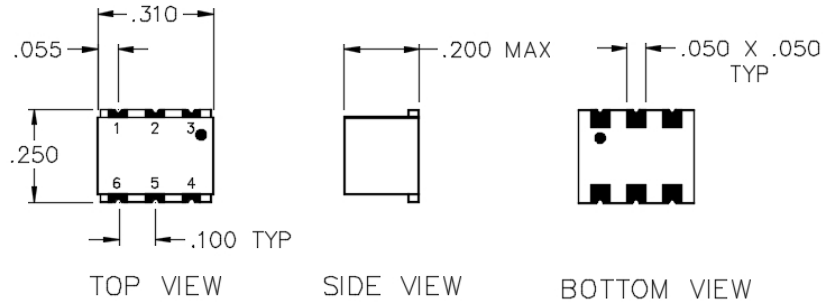

SPECIFICATIONS

Name:	QT-11-D
Bandwidth:	10%
Center Frequency:	20 MHz
Frequency Range:	19-21 MHz
Insertion Loss:	0.3 dB max.
Isolation:	25 dB min.
Amplitude Balance:	0.7 dB max.
Phase Balance:	2° max.
VSWR:	1.20:1 max.
Package Type:	Surface

PORT CONFIGURATION

Input:	1
90° Output:	6
0° Output:	4
Isolated:	3
Ground:	2, 5

Power rating 1 watt max. for load VSWR better than 1.20:1.

This is a commercial off the shelf (COTS) product.
For an equivalent product that meets DFARS materials compliance, contact sales.
All specifications are subject to change without notice at any time. Rev: 160203

