

QT-01-412

3 DB SMA 90° HYBRID COUPLER

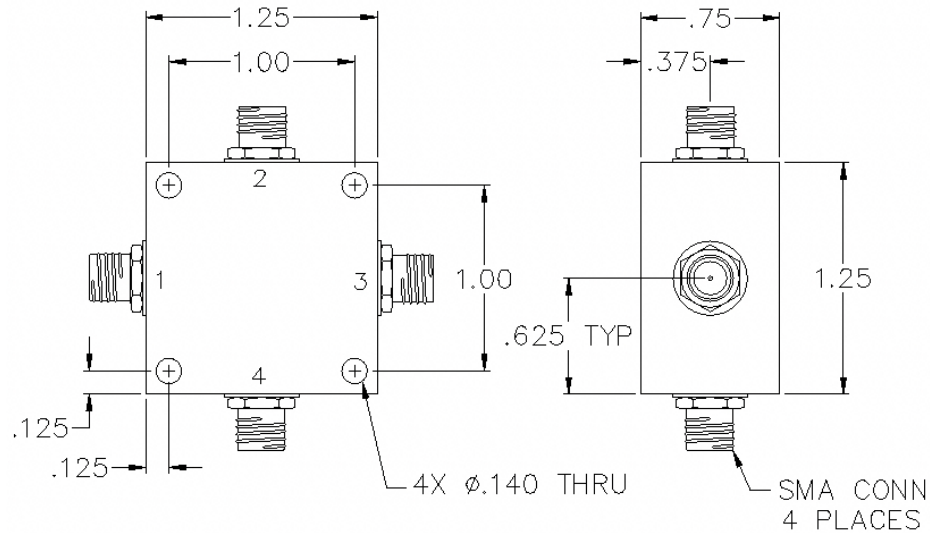

SPECIFICATIONS

Name:	QT-01-412
Bandwidth:	10%
Center Frequency:	1.25 MHz
Frequency Range:	1.18-1.31 MHz
Insertion Loss:	0.3 dB max.
Isolation:	25 dB min.
Amplitude Balance:	0.7 dB max.
Phase Balance:	2° max.
VSWR:	1.20:1 max.
Package Type:	SMA

PORT CONFIGURATION

Input:	1
90° Output:	4
0° Output:	2
Isolated:	3
Ground:	Housing

Power rating 1 watt max. for load VSWR better than 1.20:1.

This is a commercial off the shelf (COTS) product.

For an equivalent product that meets DFARS materials compliance, contact sales.

All specifications are subject to change without notice at any time. Rev: 220628