

# PS2-51-450/13S

## 2-WAY SMA POWER DIVIDER

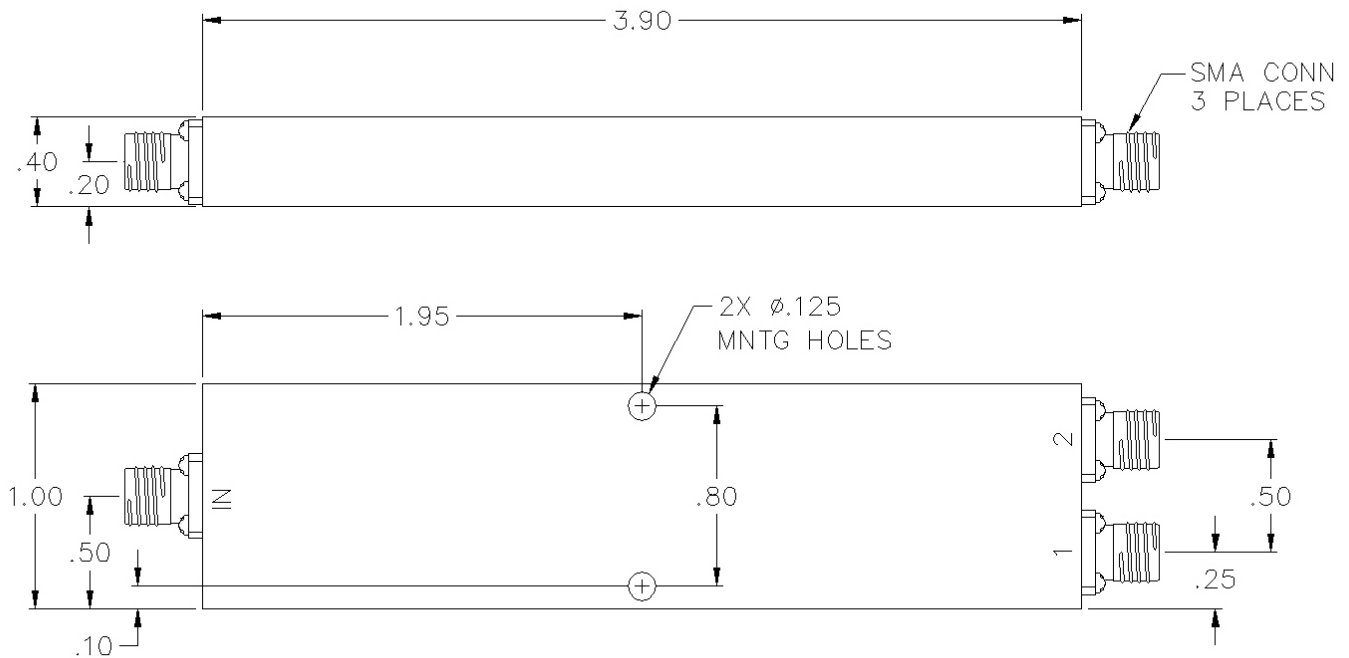

## SPECIFICATIONS

Name:	PS2-51-450/13S
Frequency Range:	1-27 GHz
Insertion Loss:	2.5 dB max.
Isolation:	15 dB min.
Amplitude Balance:	0.5 dB max.
Phase Balance:	8° max.
VSWR:	1.80:1 max.
Input Power:	10 watts max.
Connector Type:	SMA

Input power is specified for load VSWR better than 1.20:1.  
BNC, TNC, and F connectors and other frequency ranges also available, contact sales.  
Higher power models available, contact sales.

This is a commercial off the shelf (COTS) product.  
For an equivalent product that meets DFARS materials compliance, contact sales.  
All specifications are subject to change without notice at any time. Rev: 190326

www.pulsarmicrowave.com · 48 Industrial St West, Clifton NJ 07012 · Tel: 973-779-6262 · Fax: 973-779-2727 · sales@pulsarmicrowave.com

**PULSAR**  
MICROWAVE CORPORATION