

PS2-27-450/10S

2-WAY SMA POWER DIVIDER

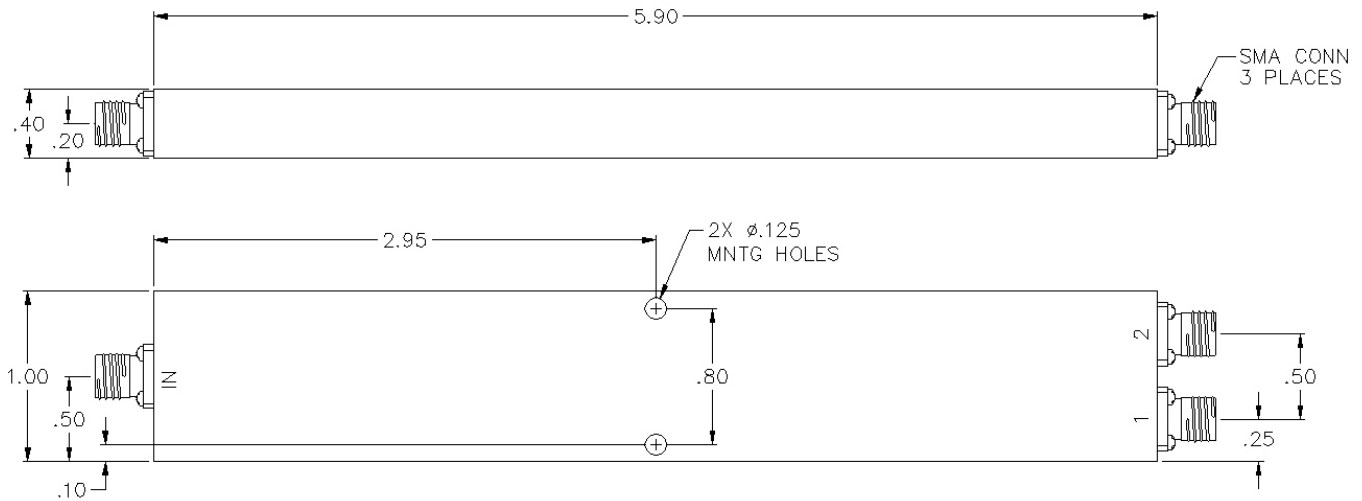

SPECIFICATIONS

Name:	PS2-27-450/10S
Frequency Range:	0.5-8 GHz
Insertion Loss:	1.0 dB max.
Isolation:	18 dB min.
Amplitude Balance:	0.5 dB max.
Phase Balance:	5° max.
VSWR:	1.50:1 max.
Input Power:	30 watts max.
Connector Type:	SMA

Input power is specified for load VSWR better than 1.20:1.
BNC, TNC, and F connectors and other frequency ranges also available, contact sales.
Higher power models available, contact sales.

This is a commercial off the shelf (COTS) product.
For an equivalent product that meets DFARS materials compliance, contact sales.
All specifications are subject to change without notice at any time. Rev: 190326

