

# MT-04-S

## HIGH FREQUENCY DROP-IN RF MIXER

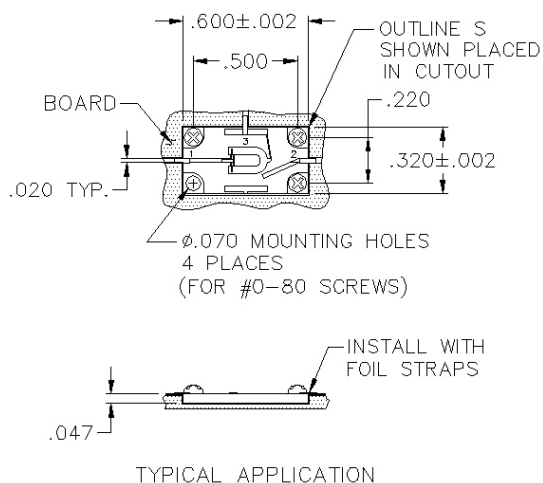

### SPECIFICATIONS

Name:	MT-04-S
Frequency Range:	
LO/RF:	2-8 GHz
IF:	DC-2.0 GHz
LO Drive:	+13 dBm
Conversion Loss:	6.5 dB typ. 8.0 dB max.
1 dB Compression Point:	+7 dBm typ.
L/R Isolation:	30 dB typ. 25 dB min.
L/I Isolation:	25 dB typ. 20 dB min.
Package Type:	Drop-In

### PORT CONFIGURATION

RF:	2
LO:	1
IF:	3

This is a commercial off the shelf (COTS) product.  
For an equivalent product that meets DFARS materials compliance, contact sales.  
All specifications are subject to change without notice at any time. Rev: 190326

