

# MT-02-SC

## HIGH FREQUENCY SMA RF MIXER

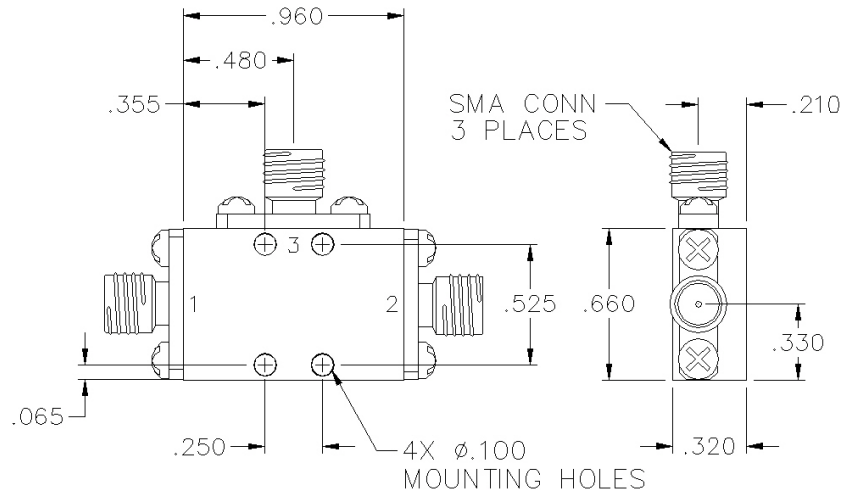

### SPECIFICATIONS

Name:	MT-02-SC
Frequency Range:	
LO/RF:	4-8 GHz
IF:	DC-2.0 GHz
LO Drive:	+13 dBm
Conversion Loss:	6.5 dB typ. 7.5 dB max.
1 dB Compression Point:	+7 dBm typ.
L/R Isolation:	40 dB typ. 35 dB min.
L/I Isolation:	35 dB typ. 30 dB min.
Package Type:	SMA

### PORT CONFIGURATION

RF:	2
LO:	1
IF:	3

This is a commercial off the shelf (COTS) product.  
For an equivalent product that meets DFARS materials compliance, contact sales.  
All specifications are subject to change without notice at any time. Rev: 190404