

# MO-04-412

## QUADRAPHASE MODULATOR

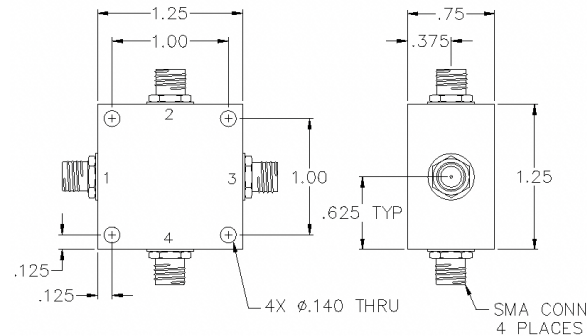

## SPECIFICATIONS

Name:	MO-04-412
Frequency Range:	60-120 MHz
Insertion Loss:	7.5 dB max.
1 dB Compression Point:	+4 dBm min.
Amplitude Balance:	0.7 dB max.
Phase Balance:	5° max.
VSWR:	1.70:1 max.
Package Type:	SMA

Specifications are for a drive current of  $\pm 20$  mA.  
Maximum RF input power is +10 dBm.  
SMA female connectors standard, also available with BNC, TNC, F, and N connectors.  
TTL Control option available, contact sales.

## PORT CONFIGURATION

Input:	1
Output:	3
D1:	2
D2:	4
Ground:	Housing

## TRUTH TABLE

Phase	D1 (mA)	D2 (mA)
0°	+20	+20
90°	+20	-20
180°	-20	-20
270°	-20	+20

This is a commercial off the shelf (COTS) product.

For an equivalent product that meets DFARS materials compliance, contact sales.

All specifications are subject to change without notice at any time. Rev: 220628

www.pulsarmicrowave.com · 48 Industrial St West, Clifton NJ 07012 · Tel: 973-779-6262 · Fax: 973-779-2727 · sales@pulsarmicrowave.com

**PULSAR**  
MICROWAVE CORPORATION