

MM-02-SC

HIGH FREQUENCY SMA RF MIXER

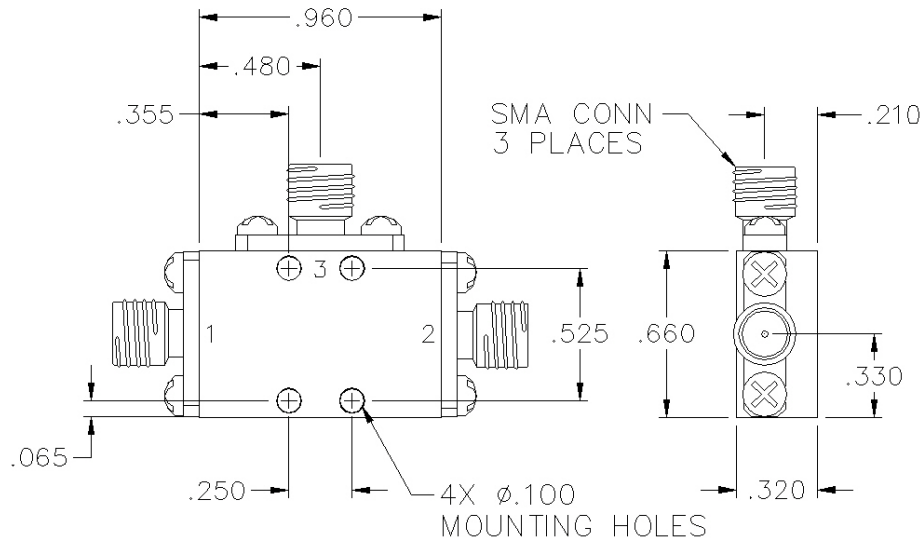

SPECIFICATIONS

Name:	MM-02-SC	
Frequency Range:	4-8 GHz	
LO/RF:	4-8 GHz	
IF:	<u>DC - 1.0</u> GHz	<u>1.0 - 2.0</u> GHz
Conversion Loss:	6.0 dB Typ 7.0 dB Max	6.5 dB Typ 7.5 dB Max
L/R Isolation:	40 dB Typ 35 dB Min	40 dB Typ 35 dB Min
L/I Isolation:	35 dB Typ 30 dB Min	35 dB Typ 30 dB Min
LO Drive:	+10 dBm	
1 dB Compression Point:	+4 dBm typ.	
Package Type:	SMA	

PORT CONFIGURATION

RF:	2
LO:	1
IF:	3

This is a commercial off the shelf (COTS) product.
For an equivalent product that meets DFARS materials compliance, contact sales.
All specifications are subject to change without notice at any time. Rev: 190404

