

MH-09-S

HIGH FREQUENCY DROP-IN RF MIXER

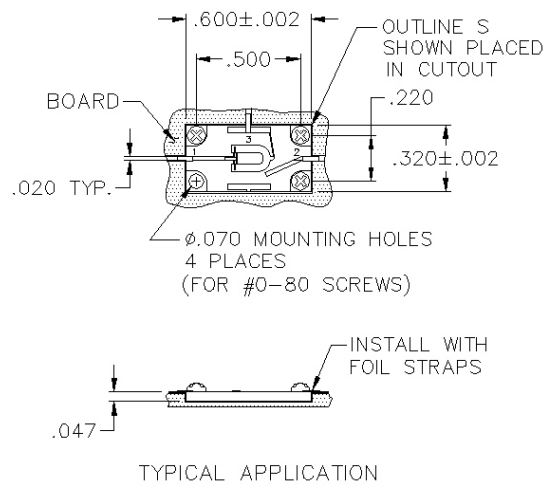

SPECIFICATIONS

Name:	MH-09-S
Frequency Range:	
LO/RF:	4-18 GHz
IF:	DC-2.0 GHz
LO Drive:	+17 dBm
Conversion Loss:	7.0 dB typ. 9.0 dB max.
1 dB Compression Point:	+10 dBm typ.
L/R Isolation:	25 dB typ. 20 dB min.
L/I Isolation:	25 dB typ. 20 dB min.
Package Type:	Drop-In

PORT CONFIGURATION

RF:	2
LO:	1
IF:	3

This is a commercial off the shelf (COTS) product.
For an equivalent product that meets DFARS materials compliance, contact sales.
All specifications are subject to change without notice at any time. Rev: 190326

