

ID-05-412

QUADRATURE I.F. MIXER (DEMODULATOR)

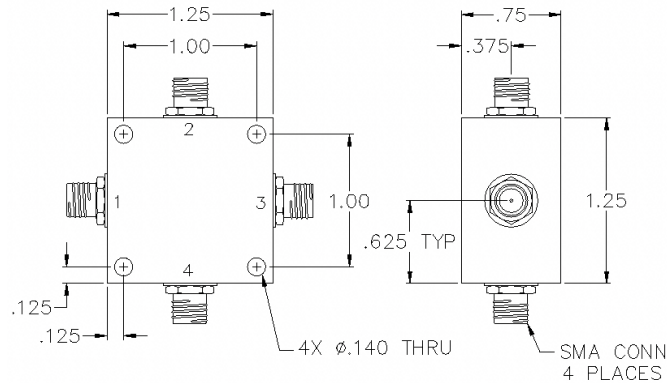

SPECIFICATIONS

Name:	ID-05-412
Carrier (LO) Frequency:	66.5-73.5 MHz
RF Frequency:	LO \pm 20 MHz
IQ Frequency:	DC-20 MHz
Conversion Loss:	10 dB max.
Amplitude Balance:	0.4 dB max.
Phase Balance:	2° max.
Isolation:	
L/R:	40 dB min.
L/I:	35 dB min.
VSWR:	1.5:1 min.
Connector Type:	SMA

PORT CONFIGURATION

RF:	3
LO:	1
I:	2
Q:	4
Ground:	Housing

Specifications apply when operating LO power level is $+10 \pm 0.5$ dBm and operating RF power level is -10 ± 0.5 dBm.

IF Frequency (Q) is $+90^\circ$ relative to IF frequency (I) when RF frequency is $>$ LO frequency. SMA female connectors standard, also available with BNC, TNC, F, and N connectors.

This is a commercial off the shelf (COTS) product.

For an equivalent product that meets DFARS materials compliance, contact sales.

All specifications are subject to change without notice at any time. Rev: 220628

www.pulsarmicrowave.com · 48 Industrial St West, Clifton NJ 07012 · Tel: 973-779-6262 · Fax: 973-779-2727 · sales@pulsarmicrowave.com

PULSAR
MICROWAVE CORPORATION