

DST-15-480/1S

DIGITAL CONTROLLED PHASE SHIFTER

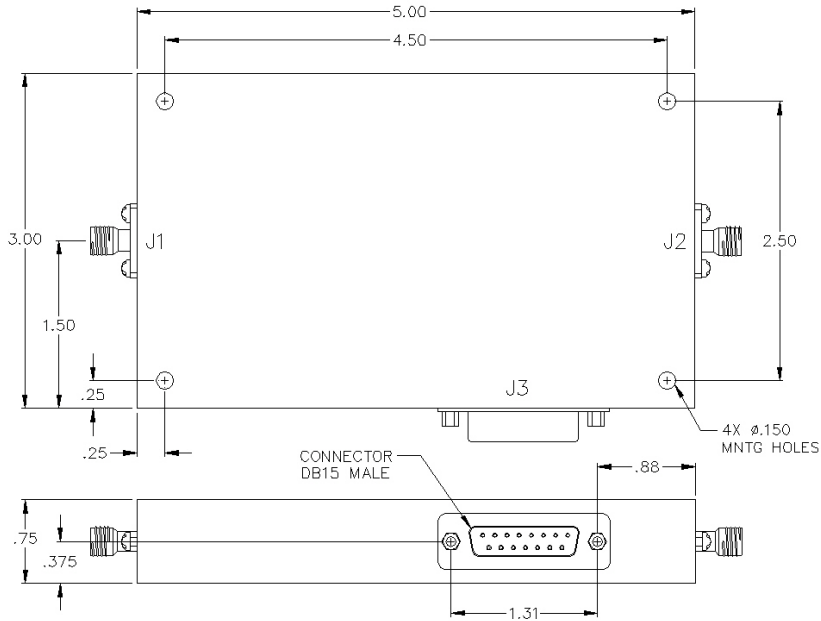

Logic Table

State	Pin 1	Pin 2	Pin 3	Pin 4	Pin 5	Pin 6	Pin 7	Pin 8	Phase (deg.)
-	1	1	1	1	1	1	1	1	0°
1	0	1	1	1	1	1	1	1	1.4°
2	1	0	1	1	1	1	1	1	2.8°
3	1	1	0	1	1	1	1	1	5.6°
4	1	1	1	0	1	1	1	1	11.2°
5	1	1	1	1	0	1	1	1	22.5°
6	1	1	1	1	1	0	1	1	45°
7	1	1	1	1	1	1	0	1	90°
8	1	1	1	1	1	1	1	0	180°

A combination of the above states will provide a phase shift equal to the sum of the selected states at center frequency.

Pin-Out



SPECIFICATIONS

Name:	DST-15-480/1S
Frequency Range:	0.05-0.06 GHz
Insertion Loss:	5.0 dB max.
Number of Bits:	8
Least Significant Bit:	1.4° LSB
Phase Range:	360°
VSWR:	1.50:1 dB max.
Connector Type:	SMA

Pin 01 = Phase: 1.4 (LSB)	Pin 09 = N/C
Pin 02 = Phase: 2.8	Pin 10 = N/C
Pin 03 = Phase: 5.6	Pin 11 = N/C
Pin 04 = Phase: 11.25	Pin 12 = N/C
Pin 05 = Phase: 22.5	Pin 13 = +5 Vdc
Pin 06 = Phase: 45	Pin 14 = -5 Vdc
Pin 07 = Phase: 90	Pin 15 = Ground
Pin 08 = Phase: 180	

Phase is $\pm 3.0\%$ at center frequency.
Other frequency bands and resolution ranges available.

This is a commercial off the shelf (COTS) product.
For an equivalent product that meets DFARS materials compliance, contact sales.
All specifications are subject to change without notice at any time. Rev: 180403

