

# CS10-05-436/11N

## 10 DB TYPE N DIRECTIONAL COUPLER

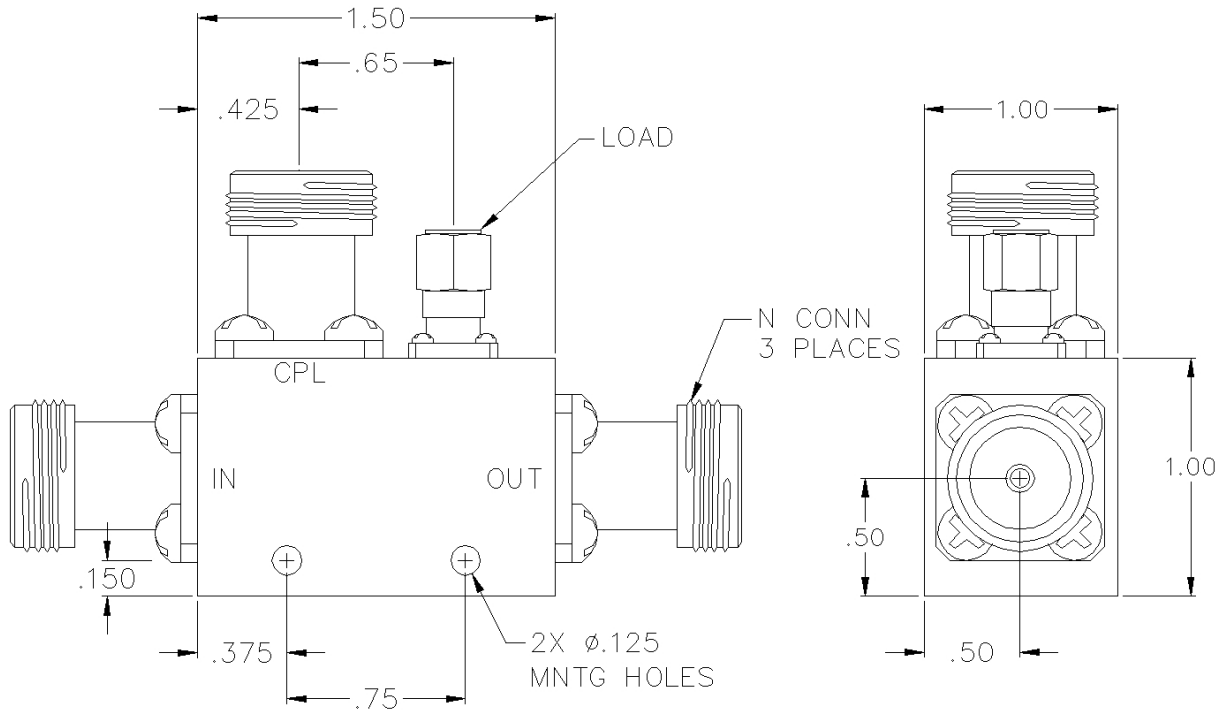

## SPECIFICATIONS

Name:	CS10-05-436/11N
Frequency Range:	2-4 GHz
Coupling:	10.0 ± 1.25 dB
Coupling Flatness:	±0.75 dB max.
Insertion Loss:	0.20 dB max.
Directivity:	18 dB min.
VSWR:	1.15:1 max.
Input Power:	50 watts max.
Reflected Power:	10 watts max.
Connector Type:	N

Insertion loss does not include coupling loss.  
Input power is specified for load VSWR better than 1.20:1.

This is a commercial off the shelf (COTS) product.  
For an equivalent product that meets DFARS materials compliance, contact sales.  
All specifications are subject to change without notice at any time. Rev: 170130

