

CS08-15-436/13

8 DB SMA DIRECTIONAL COUPLER

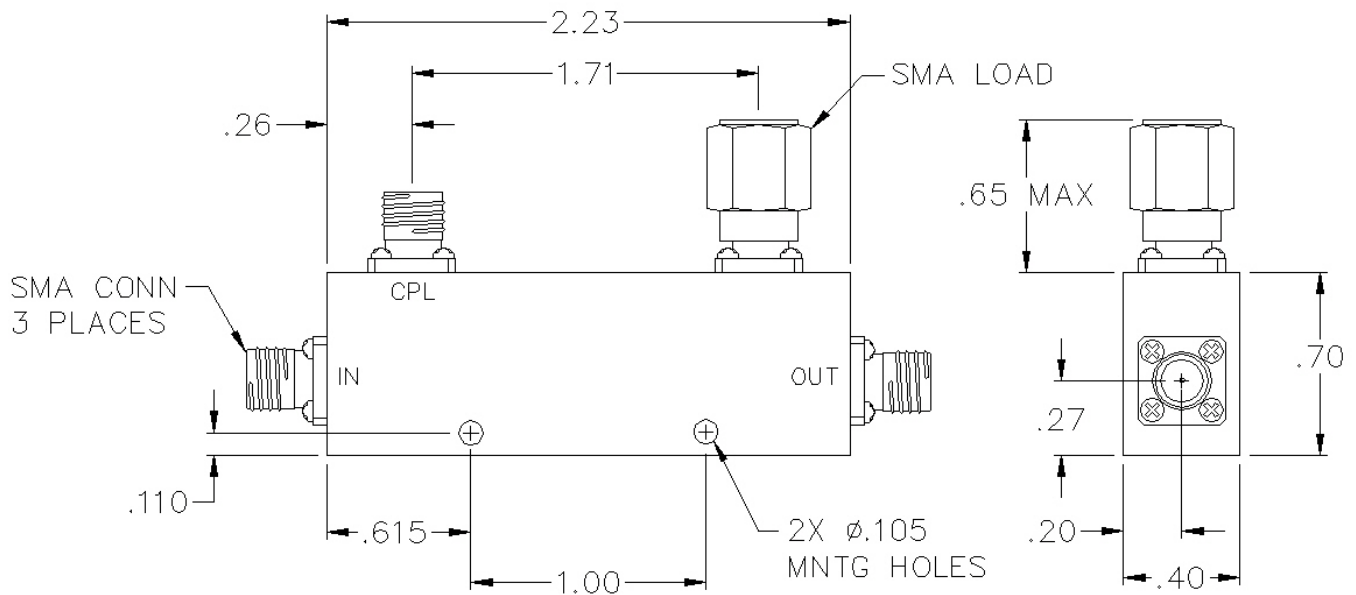

SPECIFICATIONS

Name:	CS08-15-436/13
Frequency Range:	2-18 GHz
Coupling:	8.0 ± 1.00 dB
Coupling Flatness:	±0.50 dB max.
Insertion Loss:	0.90 dB max.
Directivity:	2.0-12 GHz: 15 dB min. 12-18 GHz: 12 dB min.
VSWR:	1.50:1 max.
Input Power:	50 watts max.
Reflected Power:	4 watts max.
Connector Type:	SMA

Insertion loss does not include coupling loss.
Input power is specified for load VSWR better than 1.20:1.

This is a commercial off the shelf (COTS) product.
For an equivalent product that meets DFARS materials compliance, contact sales.
All specifications are subject to change without notice at any time. Rev: 170130

