

CS06-03-436/7N

6 DB TYPE N DIRECTIONAL COUPLER

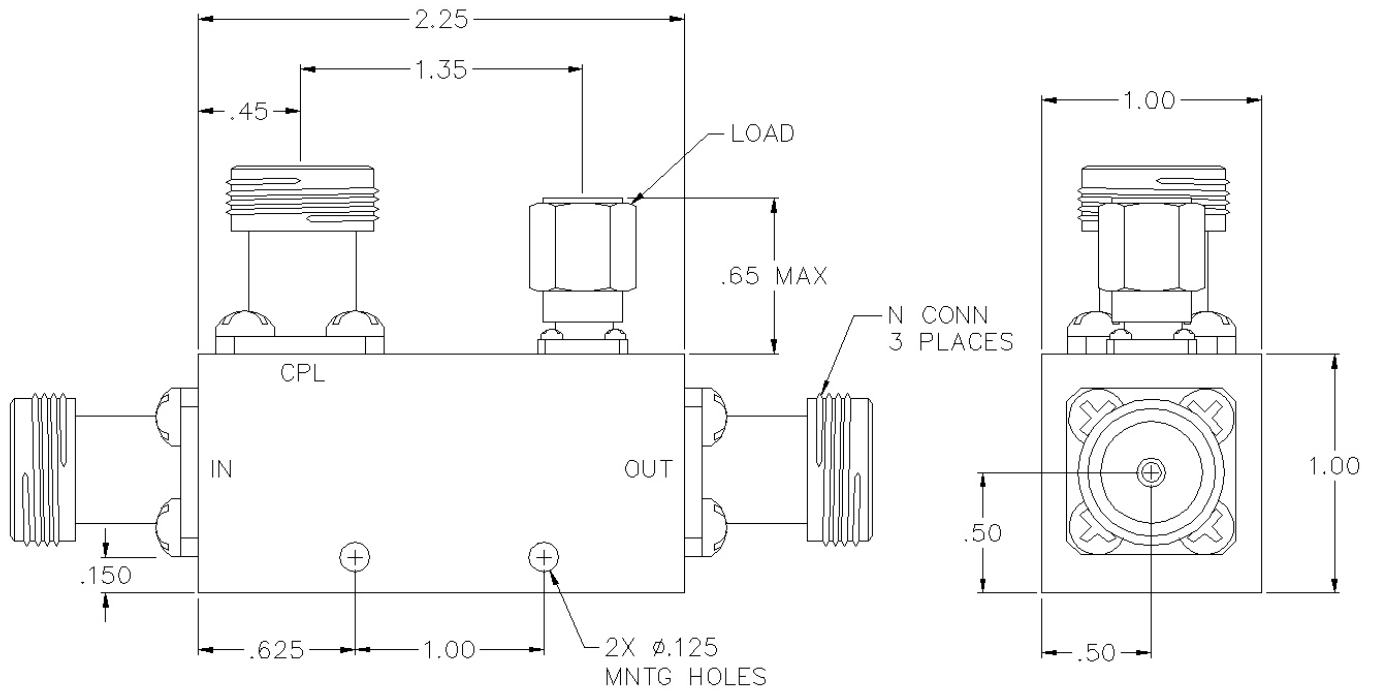

SPECIFICATIONS

Name:	CS06-03-436/7N
Frequency Range:	1-2 GHz
Coupling:	6.0 ± 1.00 dB
Coupling Flatness:	±0.60 dB max.
Insertion Loss:	0.20 dB max.
Directivity:	20 dB min.
VSWR:	1.15:1 max.
Input Power:	50 watts max.
Reflected Power:	4 watts max.
Connector Type:	N

Insertion loss does not include coupling loss.
Input power is specified for load VSWR better than 1.20:1.

This is a commercial off the shelf (COTS) product.
For an equivalent product that meets DFARS materials compliance, contact sales.
All specifications are subject to change without notice at any time. Rev: 170130

www.pulsarmicrowave.com · 48 Industrial St West, Clifton NJ 07012 · Tel: 973-779-6262 · Fax: 973-779-2727 · sales@pulsarmicrowave.com

PULSAR
MICROWAVE CORPORATION