

C2-08-414

SMA DIRECTIONAL COUPLER

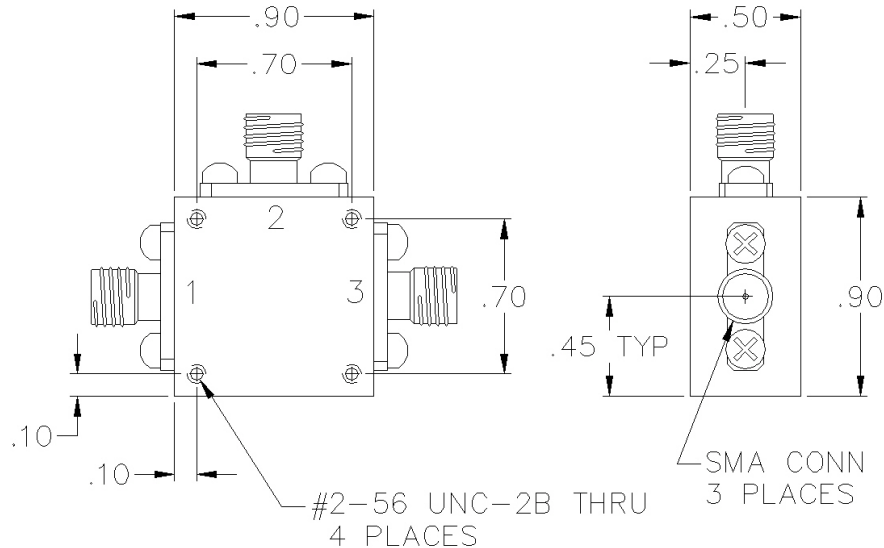

SPECIFICATIONS

Name:	C2-08-414
Frequency Range:	5-1000 MHz
Coupling:	11.5 ± 0.5 dB
Coupling Flatness:	±0.50 dB max.
Insertion Loss:	1.6 dB max.
Directivity:	23 dB min.
VSWR:	1.30:1 max.
Input Power:	1 watts max.
Connector Type:	SMA

PORT CONFIGURATION

Input:	1
Output:	3
Coupled:	2
Ground:	Housing

Insertion loss does not include coupling loss.

Input power is specified for load VSWR better than 1.20:1.

Dual directional couplers, other frequency ranges, coupling values and higher power models available.

This is a commercial off the shelf (COTS) product.

For an equivalent product that meets DFARS materials compliance, contact sales.

All specifications are subject to change without notice at any time. Rev: 220627

www.pulsarmicrowave.com · 48 Industrial St West, Clifton NJ 07012 · Tel: 973-779-6262 · Fax: 973-779-2727 · sales@pulsarmicrowave.com

PULSAR
MICROWAVE CORPORATION