

BT-51-400S

2.92MM BIAS TEE

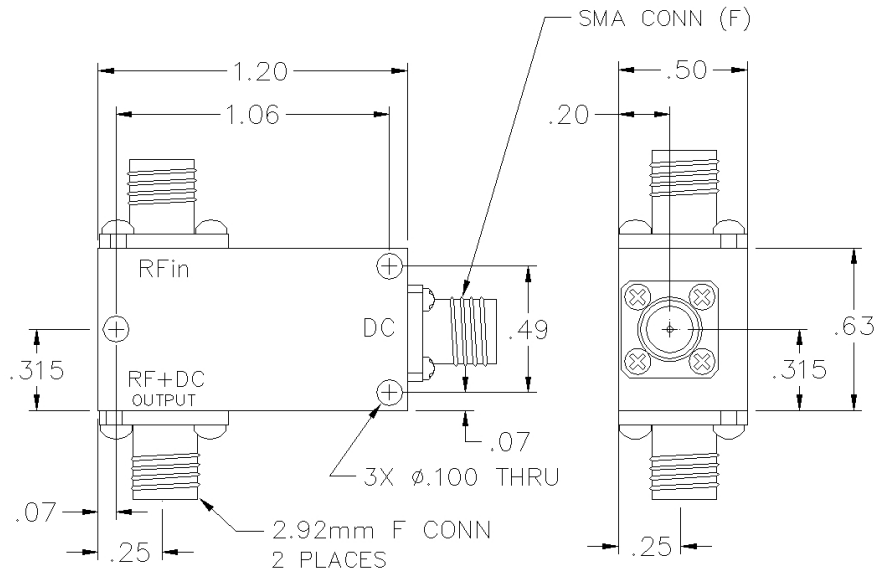

SPECIFICATIONS

Name:	BT-51-400S
Frequency Range:	30 kHz-27 GHz
Insertion Loss:	2.2 dB max.
Current:	500 mA max.
Power:	1 watts max.
Voltage:	25 Vdc max.
Isolation:	40 dB min.
VSWR:	1.80:1 max.
Package Type:	2.92

This is a commercial off the shelf (COTS) product.
For an equivalent product that meets DFARS materials compliance, contact sales.
All specifications are subject to change without notice at any time. Rev: 190404