

BT-23-411

SMA BIAS TEE

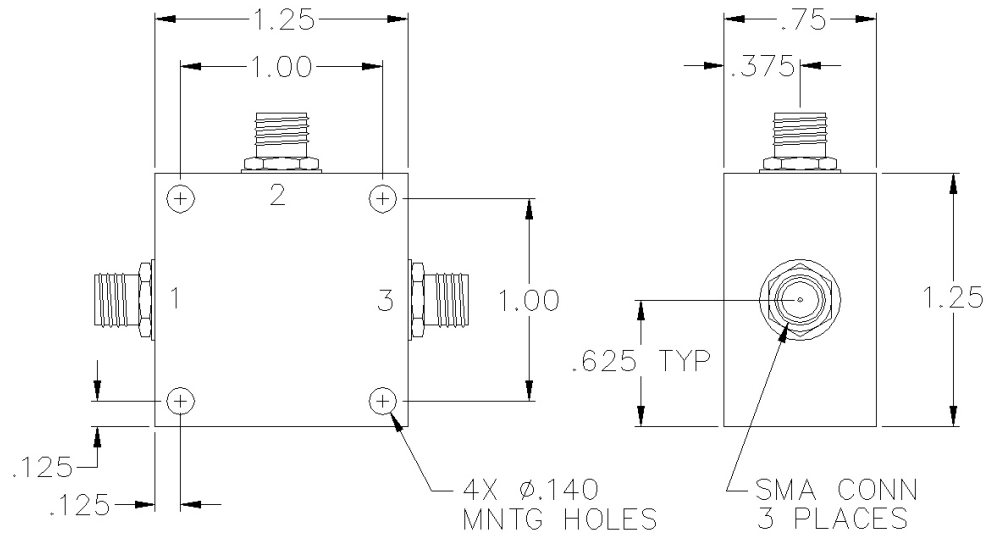

SPECIFICATIONS

Name:	BT-23-411
Frequency Range:	500-3000 MHz
Insertion Loss:	1.8 dB max.
Current:	2000 mA max.
Power:	5 watts max.
Voltage:	50 Vdc max.
Isolation:	30 dB min.
VSWR:	1.50:1 max.
Package Type:	SMA

PORT CONFIGURATION

RF In (DC Blocked):	1
RF/DC Output:	3
DC In (Bias):	2
Ground:	Housing

This is a commercial off the shelf (COTS) product.
For an equivalent product that meets DFARS materials compliance, contact sales.
All specifications are subject to change without notice at any time. Rev: 190404

