

BT-22-414

SMA BIAS TEE

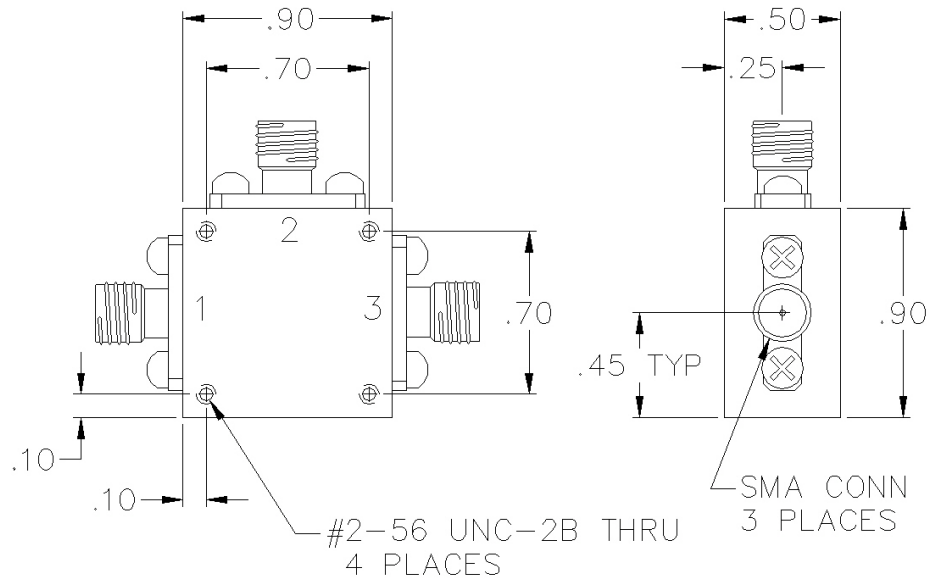
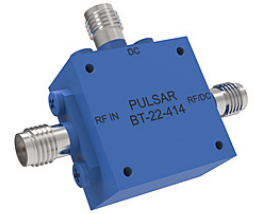

SPECIFICATIONS

Name:	BT-22-414
Frequency Range:	1700-2000 MHz
Insertion Loss:	0.5 dB max.
Current:	5000 mA max.
Power:	10 watts max.
Voltage:	100 Vdc max.
Isolation:	30 dB min.
VSWR:	1.50:1 max.
Package Type:	SMA

PORT CONFIGURATION

RF In (DC Blocked):	1
RF/DC Output:	3
DC In (Bias):	2
Ground:	Housing

This is a commercial off the shelf (COTS) product.
For an equivalent product that meets DFARS materials compliance, contact sales.
All specifications are subject to change without notice at any time. Rev: 190404