

BT-08-E

SURFACE MOUNT BIAS TEE

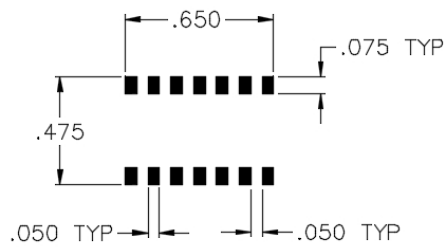

PCB PAD PATTERN
E-PHASE SHIFTER

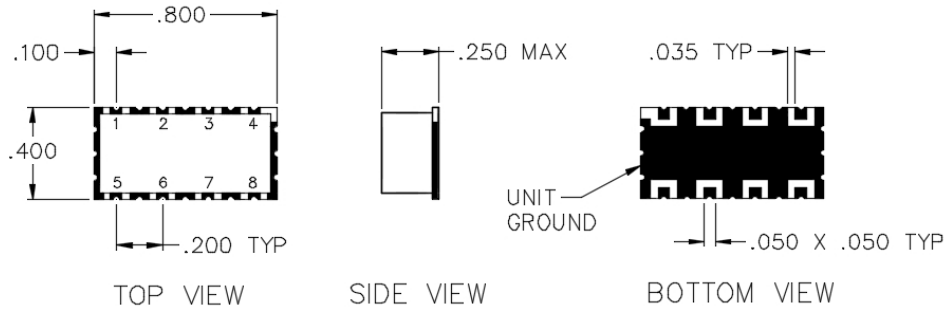
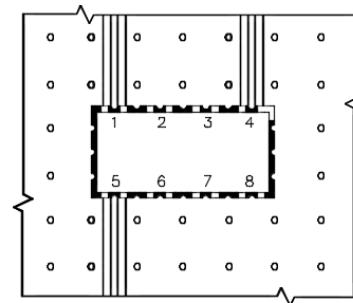

TYPICAL APPLICATION
ALL NON-USED PORTS AND UNIT GROUND
SHALL BE GROUND TO THE MAIN BOARD

SPECIFICATIONS

Name:	BT-08-E
Frequency Range:	800-1000 MHz
Insertion Loss:	0.5 dB max.
Current:	1000 mA max.
Power:	5 watts max.
Voltage:	50 Vdc max.
Isolation:	25 dB min.
VSWR:	1.20:1 max.
Package Type:	Surface

PORT CONFIGURATION

RF In (DC Blocked):	5
RF/DC Output:	1
DC In (Bias):	4

This is a commercial off the shelf (COTS) product.

For an equivalent product that meets DFARS materials compliance, contact sales.

All specifications are subject to change without notice at any time. Rev: 160203