

BT-03-E

SURFACE MOUNT BIAS TEE

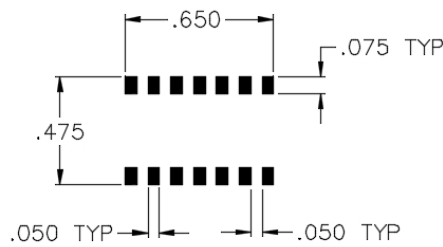

PCB PAD PATTERN
E-PHASE SHIFTER

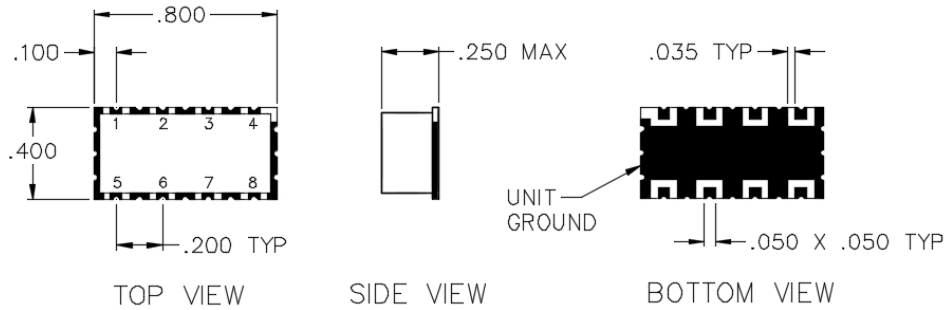
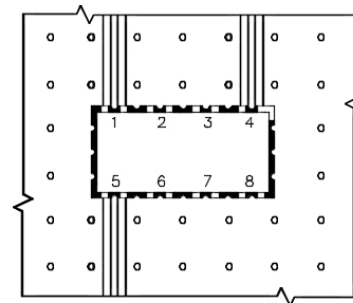

TYPICAL APPLICATION
ALL NON-USED PORTS AND UNIT GROUND
SHALL BE GROUND TO THE MAIN BOARD

SPECIFICATIONS

Name:	BT-03-E
Frequency Range:	10-4200 MHz
Insertion Loss:	1.2 dB max.
Current:	200 mA max.
Power:	1 watts max.
Voltage:	50 Vdc max.
Isolation:	20 dB min.
VSWR:	1.20:1 max.
Package Type:	Surface

PORT CONFIGURATION

RF In (DC Blocked):	5
RF/DC Output:	1
DC In (Bias):	4

This is a commercial off the shelf (COTS) product.

For an equivalent product that meets DFARS materials compliance, contact sales.

All specifications are subject to change without notice at any time. Rev: 190723