

# BT-01-414

## SMA BIAS TEE

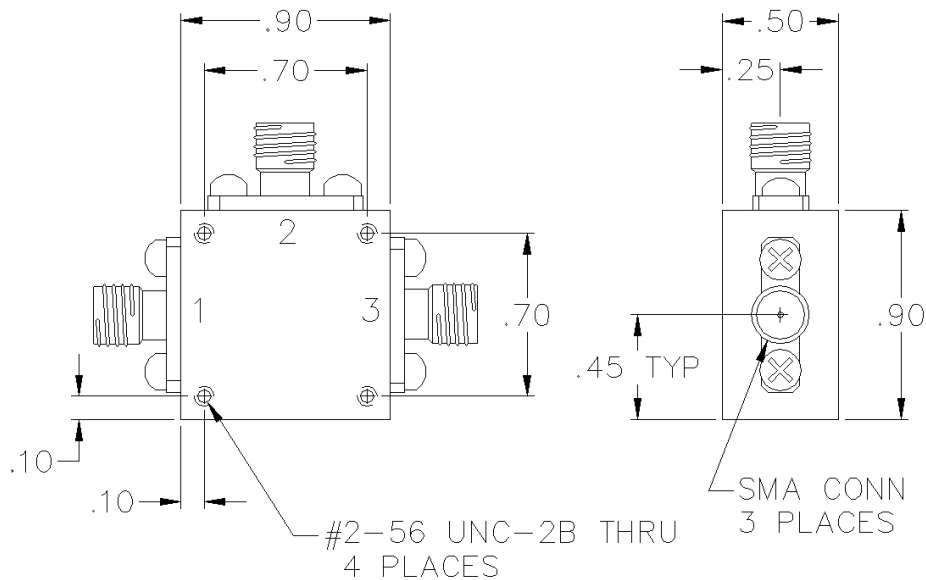
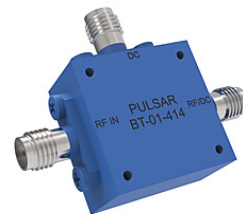

## SPECIFICATIONS

Name:	BT-01-414
Frequency Range:	10-1000 MHz
Insertion Loss:	1.0 dB max.
Current:	200 mA max.
Power:	1 watts max.
Voltage:	50 Vdc max.
Isolation:	25 dB min.
VSWR:	1.20:1 max.
Package Type:	SMA

## PORT CONFIGURATION

RF In (DC Blocked):	1
RF/DC Output:	3
DC In (Bias):	2
Ground:	Housing

This is a commercial off the shelf (COTS) product.  
For an equivalent product that meets DFARS materials compliance, contact sales.  
All specifications are subject to change without notice at any time. Rev: 190404