

BP-10-SC

BI-PHASE MODULATOR

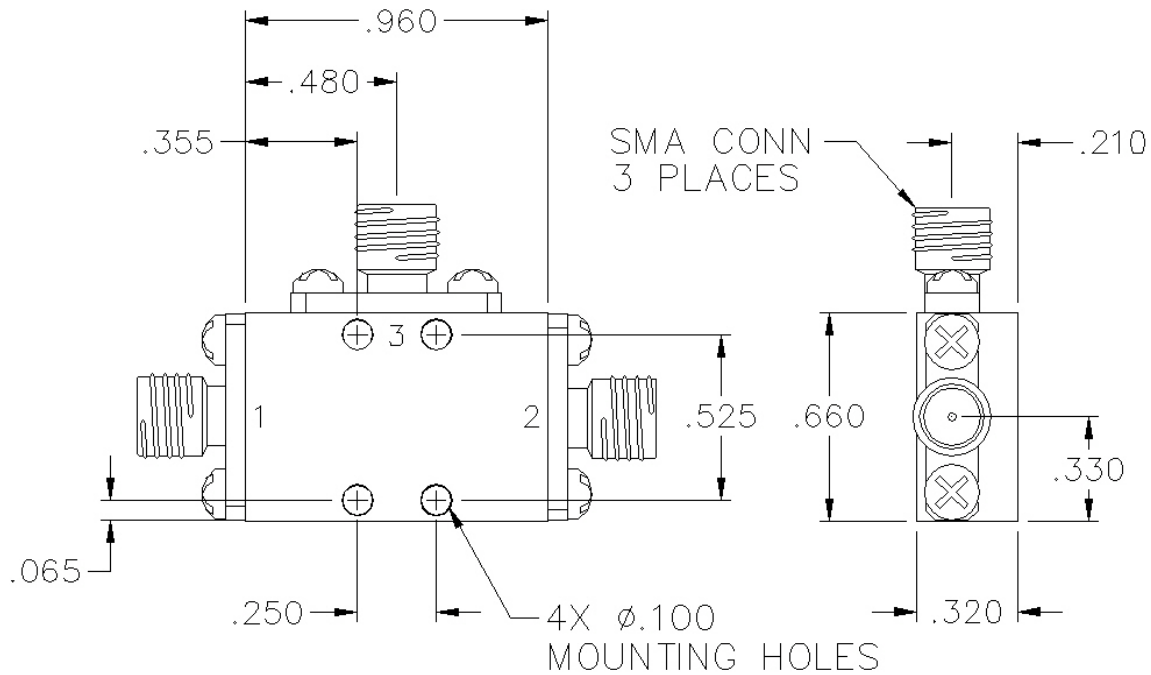

SPECIFICATIONS

Name:	BP-10-SC
Frequency Range:	6000-12000 MHz
Insertion Loss:	4.5 dB max.
Input Power:	+10 dBm max.
Amplitude Balance:	0.5 dB max.
Phase Balance:	5° max.
VSWR:	2.00:1 max.
Carrier Suppression:	25 dBc Typ.
Package Type:	SMA

Control currents are ± 20 mA DC.

PORT CONFIGURATION

Input:	1
Output:	2
D - 1:	3
Ground:	Housing

This is a commercial off the shelf (COTS) product.
For an equivalent product that meets DFARS materials compliance, contact sales.
All specifications are subject to change without notice at any time. Rev: 190404