

BP-02-411

BI-PHASE MODULATOR

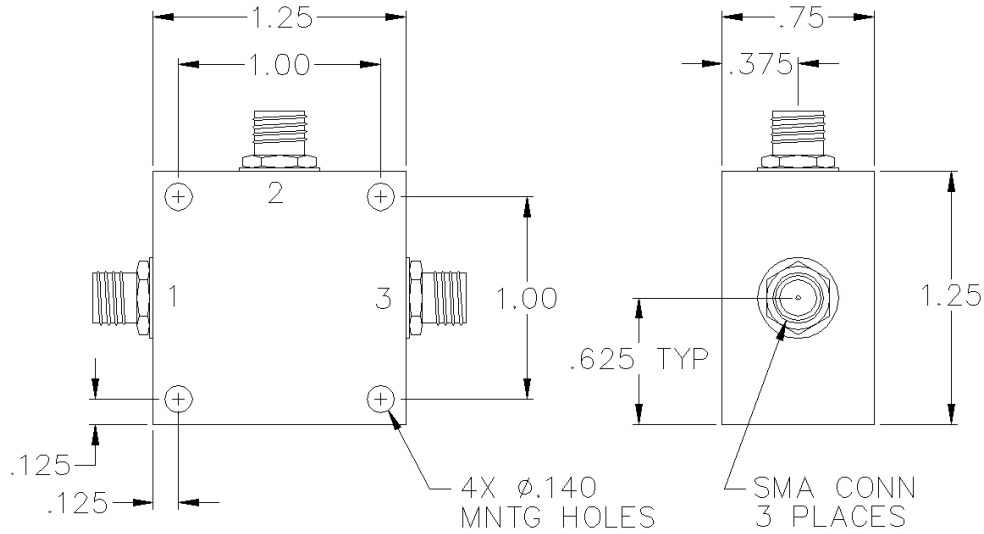
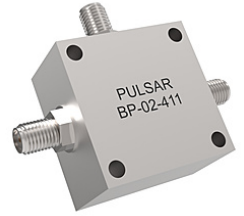

SPECIFICATIONS

Name:	BP-02-411
Frequency Range:	10-900 MHz
Insertion Loss:	4.5 dB max.
Input Power:	+10 dBm max.
Amplitude Balance:	0.4 dB max.
Phase Balance:	2° max.
VSWR:	1.70:1 max.
Carrier Suppression:	30 dBc Typ.
Package Type:	SMA

PORT CONFIGURATION

Input:	1
Output:	3
D -1:	2
Ground:	Housing

Control currents are ± 20 mA DC.

SMA female connectors standard, also available with BNC, TNC, F, and N connectors.

This is a commercial off the shelf (COTS) product.

For an equivalent product that meets DFARS materials compliance, contact sales.

All specifications are subject to change without notice at any time. Rev: 190404

www.pulsarmicrowave.com · 48 Industrial St West, Clifton NJ 07012 · Tel: 973-779-6262 · Fax: 973-779-2727 · sales@pulsarmicrowave.com

PULSAR
MICROWAVE CORPORATION