

BP-01-412

BI-PHASE MODULATOR

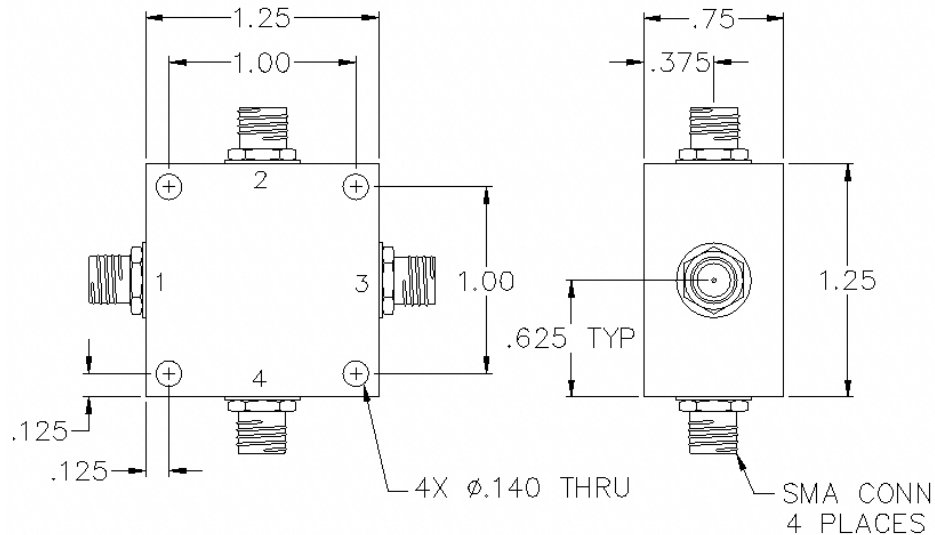

SPECIFICATIONS

| | |
|----------------------|--------------|
| Name: | BP-01-412 |
| Frequency Range: | 1-400 MHz |
| Insertion Loss: | 3.0 dB max. |
| Input Power: | +10 dBm max. |
| Amplitude Balance: | 0.2 dB max. |
| Phase Balance: | 2° max. |
| VSWR: | 1.70:1 max. |
| Carrier Suppression: | 40 dBc Typ. |
| Package Type: | SMA |

Control currents are ± 20 mA DC.

PORT CONFIGURATION

| | |
|---------|---------|
| Input: | 1 |
| Output: | 3 |
| D - 1: | 2 |
| D - 2: | 4 |
| Ground: | Housing |

This is a commercial off the shelf (COTS) product.

For an equivalent product that meets DFARS materials compliance, contact sales.

All specifications are subject to change without notice at any time. Rev: 220628

www.pulsarmicrowave.com · 48 Industrial St West, Clifton NJ 07012 · Tel: 973-779-6262 · Fax: 973-779-2727 · sales@pulsarmicrowave.com

PULSAR
MICROWAVE CORPORATION