

CS30-11-436/11N

30 DB TYPE N DIRECTIONAL COUPLER

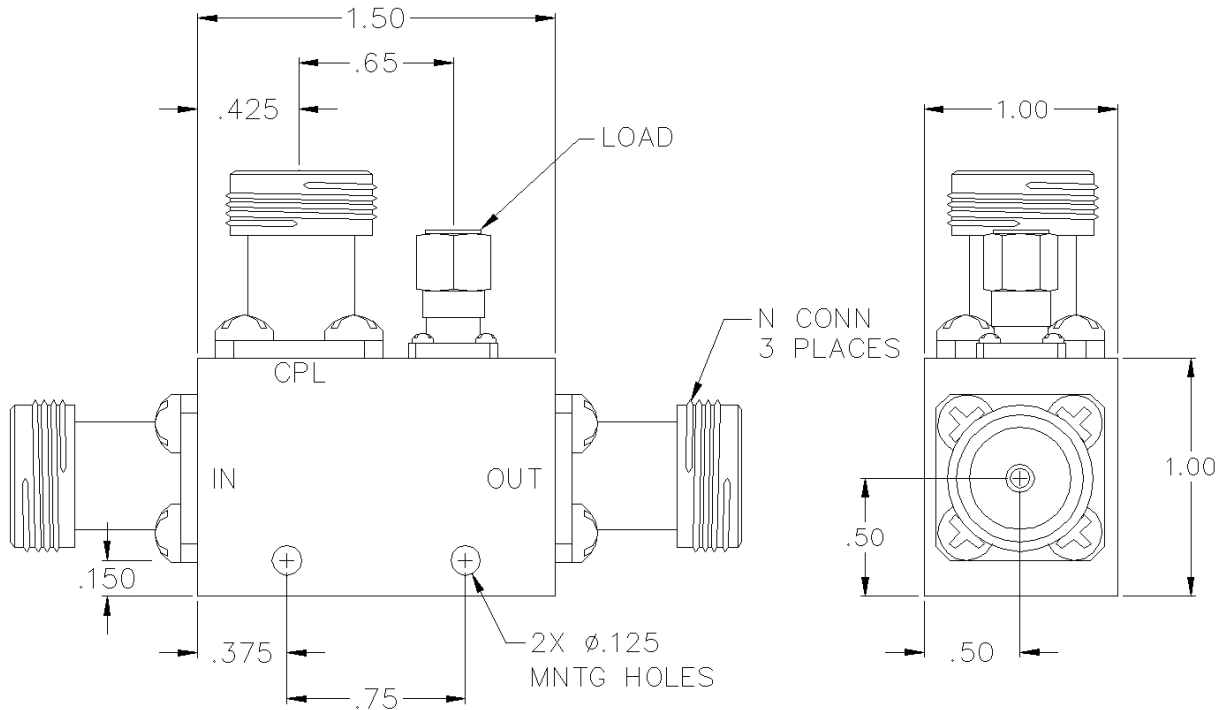

SPECIFICATIONS

Name:	CS30-11-436/11N
Frequency Range:	7.2-8.5 GHz
Coupling:	30.0 ± 1.00 dB
Coupling Flatness:	±0.30 dB max.
Insertion Loss:	0.50 dB max.
Directivity:	15 dB min.
VSWR:	1.40:1 max.
Input Power:	50 watts max.
Reflected Power:	50 watts max.
Connector Type:	N

Insertion loss does not include coupling loss.
Input power is specified for load VSWR better than 1.20:1.

This is a commercial off the shelf (COTS) product.
For an equivalent product that meets DFARS materials compliance, contact sales.
All specifications are subject to change without notice at any time. Rev: 170130

