

CCS20-07-437/1

20 DB SMA DUAL DIRECTIONAL COUPLER

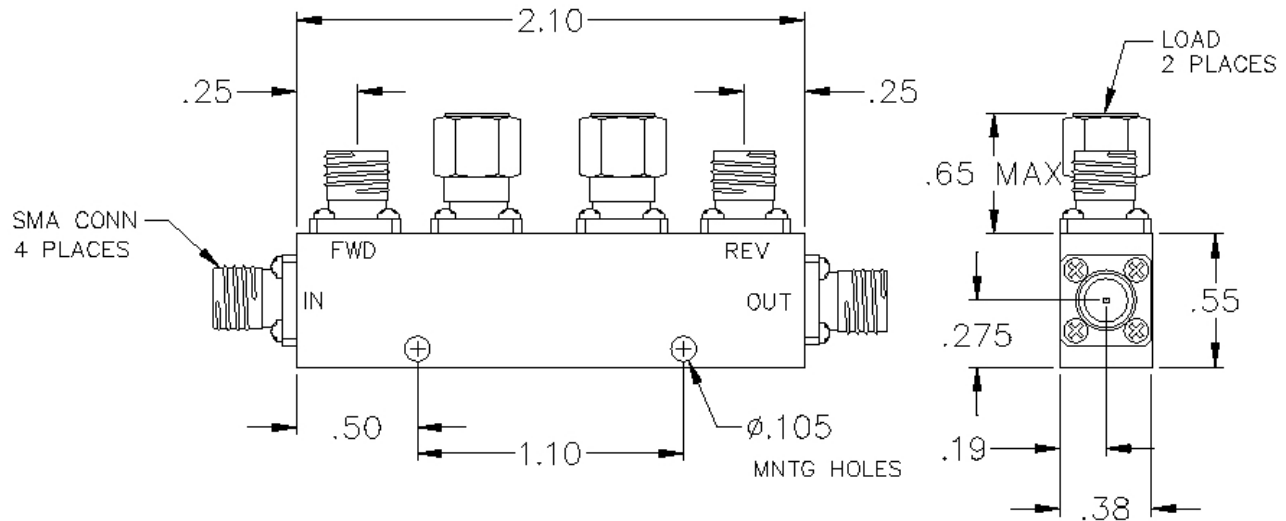

SPECIFICATIONS

Name:	CCS20-07-437/1
Frequency Range:	2.6-5.2 GHz
Coupling:	20.0 \pm 1.25 dB
Coupling Flatness:	\pm 0.80 dB max.
Insertion Loss:	0.50 dB max.
Directivity:	18 dB min.
VSWR:	1.30:1 max.
Input Power:	50 watts max.
Connector Type:	SMA

Insertion loss does not include coupling loss.
Input power is specified for load VSWR better than 1.20:1.

This is a commercial off the shelf (COTS) product.
For an equivalent product that meets DFARS materials compliance, contact sales.
All specifications are subject to change without notice at any time. Rev: 180212

