

C2-03-414

SMA DIRECTIONAL COUPLER

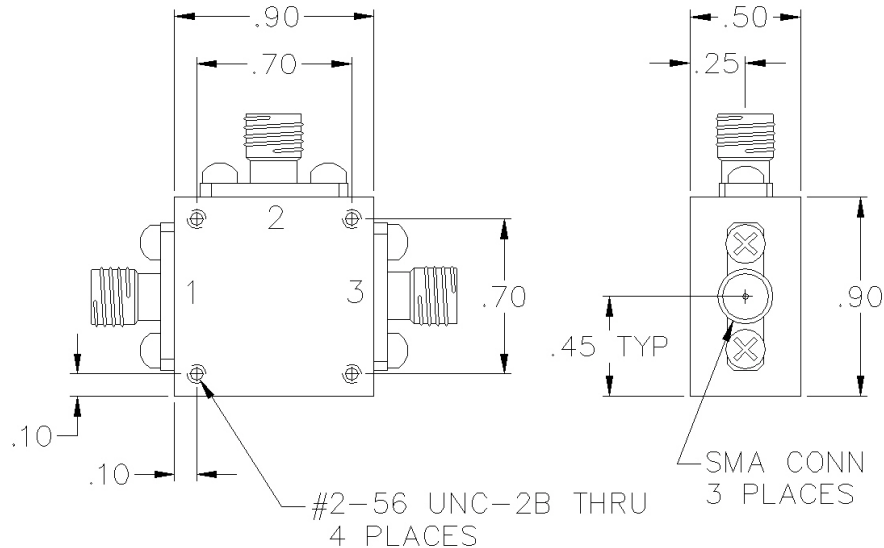

SPECIFICATIONS

| | |
|--------------------|---------------|
| Name: | C2-03-414 |
| Frequency Range: | 0.5-100 MHz |
| Coupling: | 11.5 ± 0.5 dB |
| Coupling Flatness: | ±0.25 dB max. |
| Insertion Loss: | 0.8 dB max. |
| Directivity: | 30 dB min. |
| VSWR: | 1.20:1 max. |
| Input Power: | 1 watts max. |
| Connector Type: | SMA |

PORT CONFIGURATION

| | |
|----------|---------|
| Input: | 1 |
| Output: | 3 |
| Coupled: | 2 |
| Ground: | Housing |

Insertion loss does not include coupling loss.

Input power is specified for load VSWR better than 1.20:1.

Dual directional couplers, other frequency ranges, coupling values and higher power models available.

This is a commercial off the shelf (COTS) product.

For an equivalent product that meets DFARS materials compliance, contact sales.

All specifications are subject to change without notice at any time. Rev: 220627

www.pulsarmicrowave.com · 48 Industrial St West, Clifton NJ 07012 · Tel: 973-779-6262 · Fax: 973-779-2727 · sales@pulsarmicrowave.com

PULSAR
MICROWAVE CORPORATION