

MT-06-SC

HIGH FREQUENCY SMA RF MIXER

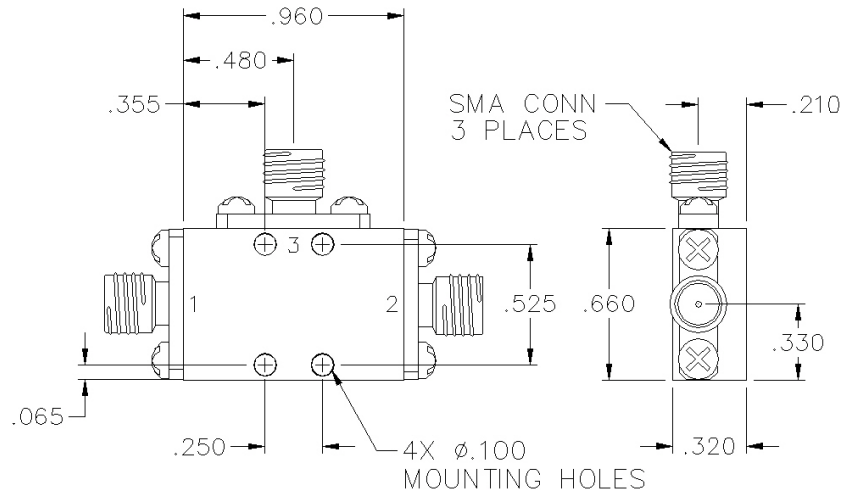

SPECIFICATIONS

Name:	MT-06-SC
Frequency Range:	
LO/RF:	5-7 GHz
IF:	DC-1.0 GHz
LO Drive:	+13 dBm
Conversion Loss:	5.0 dB typ. 6.0 dB max.
1 dB Compression Point:	+7 dBm typ.
L/R Isolation:	45 dB typ. 40 dB min.
L/I Isolation:	35 dB typ. 30 dB min.
Package Type:	SMA

PORT CONFIGURATION

RF:	2
LO:	1
IF:	3

This is a commercial off the shelf (COTS) product.
For an equivalent product that meets DFARS materials compliance, contact sales.
All specifications are subject to change without notice at any time. Rev: 190404