

# CS06-23-436/20

## 6 DB SMA DIRECTIONAL COUPLER

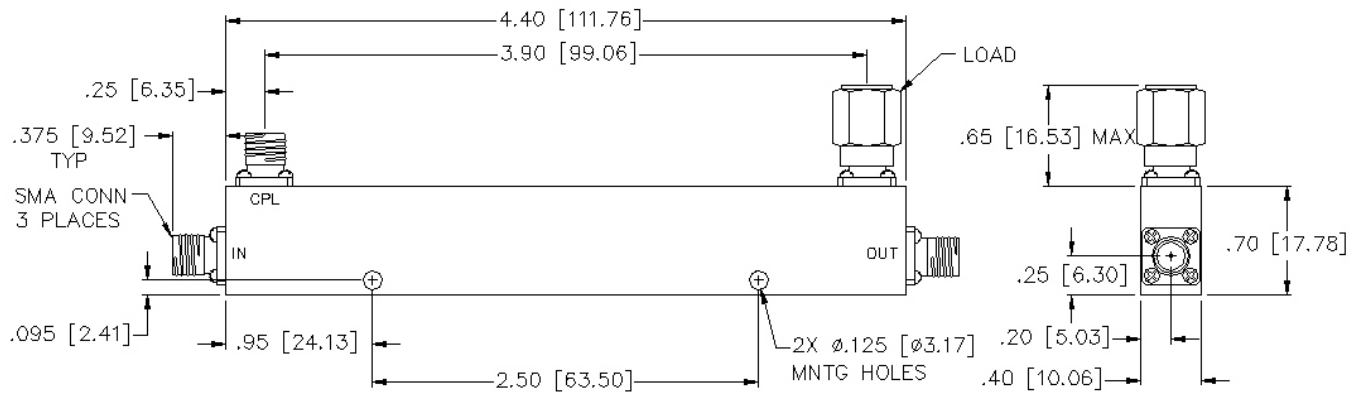

## SPECIFICATIONS

Name:	CS06-23-436/20
Frequency Range:	0.5-18 GHz
Coupling:	6.0 ± 1.00 dB
Coupling Flatness:	±1.00 dB max.
Insertion Loss:	1.80 dB max.
Directivity:	15 dB min.
VSWR:	1.50:1 max.
Input Power:	25 watts max.
Reflected Power:	10 watts max.
Connector Type:	SMA

Insertion loss does not include coupling loss.  
Input power is specified for load VSWR better than 1.20:1.

This is a commercial off the shelf (COTS) product.  
For an equivalent product that meets DFARS materials compliance, contact sales.  
All specifications are subject to change without notice at any time. Rev: 220317

